

SHURE®

LEGENDARY
PERFORMANCE™

ULX-D



ULX-D Digital Wireless Microphone System



IMPORTANT SAFETY INSTRUCTIONS

1. READ these instructions.
2. KEEP these instructions.
3. HEED all warnings.
4. FOLLOW all instructions.
5. DO NOT use this apparatus near water.
6. CLEAN ONLY with dry cloth.
7. DO NOT block any ventilation openings. Install in accordance with the manufacturer's instructions.
8. DO NOT install near any heat sources such as radiators, heat registers, stoves, or other apparatus (including amplifiers) that produce heat.
9. DO NOT defeat the safety purpose of the polarized or grounding type plug. A polarized plug has two blades with one wider than the other. A grounding type plug has two blades and a third grounding prong. The wider blade or the third prong are provided for your safety. If the provided plug does not fit into your outlet, consult an electrician for replacement of the obsolete outlet.
10. PROTECT the power cord from being walked on or pinched, particularly at plugs, convenience receptacles, and the point where they exit from the apparatus.
11. ONLY USE attachments/accessories specified by the manufacturer.
12. USE only with a cart, stand, tripod, bracket, or table specified by the manufacturer, or sold with the apparatus. When a cart is used, use caution when moving the cart/apparatus combination to avoid injury from tip-over.
13. UNPLUG this apparatus during lightning storms or when unused for long periods of time.



14. REFER all servicing to qualified service personnel. Servicing is required when the apparatus has been damaged in any way, such as power supply cord or plug is damaged, liquid has been spilled or objects have fallen into the apparatus, the apparatus has been exposed to rain or moisture, does not operate normally, or has been dropped.
15. DO NOT expose the apparatus to dripping and splashing. DO NOT put objects filled with liquids, such as vases, on the apparatus.
16. The MAINS plug or an appliance coupler shall remain readily operable.
17. The airborne noise of the Apparatus does not exceed 70dB (A).
18. Apparatus with CLASS I construction shall be connected to a MAINS socket outlet with a protective earthing connection.
19. To reduce the risk of fire or electric shock, do not expose this apparatus to rain or moisture.
20. Do not attempt to modify this product. Doing so could result in personal injury and/or product failure.



This symbol indicates that dangerous voltage constituting a risk of electric shock is present within this unit.



This symbol indicates that there are important operating and maintenance instructions in the literature accompanying this unit.

WARNING: This product contains a chemical known to the State of California to cause cancer and birth defects or other reproductive harm.

CONSIGNES DE SÉCURITÉ IMPORTANTES

1. LIRE ces consignes.
2. CONSERVER ces consignes.
3. OBSERVER tous les avertissements.
4. SUIVRE toutes les consignes.
5. NE PAS utiliser cet appareil à proximité de l'eau.
6. NETTOYER UNIQUEMENT avec un chiffon sec.
7. NE PAS obstruer les ouvertures de ventilation. Installer en respectant les consignes du fabricant.
8. NE PAS installer à proximité d'une source de chaleur telle que radiateur, bouche de chaleur, poêle ou autres appareils (dont les amplificateurs) produisant de la chaleur.
9. NE PAS détériorer la sécurité de la fiche polarisée ou de la fiche de terre. Une fiche polarisée comporte deux lames dont l'une est plus large que l'autre. Une fiche de terre comporte deux lames et une troisième broche de mise à la terre. La lame la plus large ou la troisième broche assure la sécurité de l'utilisateur. Si la fiche fournie ne s'adapte pas à la prise électrique, demander à un électricien de remplacer la prise hors normes.
10. PROTÉGER le cordon d'alimentation afin que personne ne marche dessus et que rien ne le pinçe, en particulier au niveau des fiches, des prises de courant et du point de sortie de l'appareil.
11. UTILISER UNIQUEMENT les accessoires spécifiés par le fabricant.
12. UTILISER uniquement avec un chariot, un pied, un trépied, un support ou une table spécifié par le fabricant ou vendu avec l'appareil. Si un chariot est utilisé, déplacer l'ensemble chariot-appareil avec précaution afin de ne pas le renverser, ce qui pourrait entraîner des blessures.



13. DÉBRANCHER l'appareil pendant les orages ou quand il ne sera pas utilisé pendant longtemps.
14. CONFIER toute réparation à du personnel qualifié. Des réparations sont nécessaires si l'appareil est endommagé d'une façon quelconque, par exemple : cordon ou prise d'alimentation endommagé, liquide renversé ou objet tombé à l'intérieur de l'appareil, exposition de l'appareil à la pluie ou à l'humidité, appareil qui ne marche pas normalement ou que l'on a fait tomber.
15. NE PAS exposer cet appareil aux égouttures et aux éclaboussures. NE PAS poser des objets contenant de l'eau, comme des vases, sur l'appareil.
16. La prise SECTEUR ou un coupleur d'appareil électrique doit rester facilement utilisable.
17. Le bruit aérien de l'appareil ne dépasse pas 70 dB (A).
18. L'appareil de construction de CLASSE I doit être raccordé à une prise SECTEUR dotée d'une protection par mise à la terre.
19. Pour réduire les risques d'incendie ou de choc électrique, ne pas exposer cet appareil à la pluie ou à l'humidité.
20. Ne pas essayer de modifier ce produit. Cela risque de causer des blessures et/ou la défaillance du produit.



Ce symbole indique la présence d'une tension dangereuse dans l'appareil constituant un risque de choc électrique.



Ce symbole indique que la documentation fournie avec l'appareil contient des instructions d'utilisation et d'entretien importantes.

WICHTIGE SICHERHEITSHINWEISE

1. Diese Hinweise LESEN.
2. Diese Hinweise AUFBEWAHREN.
3. Alle Warnungen BEACHTEN.
4. Alle Hinweise BEFOLGEN.
5. Dieses Gerät NICHT in Wassernähe VERWENDEN.
6. NUR mit einem sauberen Tuch REINIGEN.
7. KEINE Lüftungsöffnungen verdecken. Gemäß den Anweisungen des Herstellers installieren.
8. NICHT in der Nähe von Wärmequellen wie zum Beispiel Heizkörpern, Wärmespeichern, Öfen oder anderen Hitze erzeugenden Geräten (einschließlich Verstärkern) installieren.
9. Die Schutzfunktion des Schukosteckers NICHT umgehen. Ein Schukostecker verfügt über zwei Steckerzinken sowie Schutzleiter. Bei dieser Steckerausführung dienen die Schutzleiter Ihrer Sicherheit. Wenn der mitgelieferte Stecker nicht in die Steckdose passt, einen Elektriker mit dem Austauschen der veralteten Steckdose beauftragen.
10. VERHINDERN, dass das Netzkabel gequetscht oder darauf getreten wird, insbesondere im Bereich der Stecker, Netzsteckdosen und an der Austrittsstelle vom Gerät.
11. NUR das vom Hersteller angegebene Zubehör und entsprechende Zusatzgeräte verwenden.
12. NUR in Verbindung mit einem vom Hersteller angegebenen oder mit dem Gerät verkauften Transportwagen, Stand, Stativ, Träger oder Tisch verwenden. Wenn ein Transportwagen verwendet wird, beim Verschieben der Transportwagen/Geräte-Einheit vorsichtig vorgehen, um Verletzungen durch Umkippen zu verhüten.



13. Bei Gewitter oder wenn das Gerät lange Zeit nicht benutzt wird, das Netzkabel HER-AUSZIEHEN.
14. ALLE Reparatur- und Wartungsarbeiten von qualifiziertem Kundendienstpersonal durchführen lassen. Kundendienst ist erforderlich, wenn das Gerät auf irgendwelche Weise beschädigt wurde, z. B. wenn das Netzkabel oder der Netzstecker beschädigt wurden, wenn Flüssigkeiten in das Gerät verschüttet wurden oder Fremdkörper hineingefallen, wenn das Gerät Regen oder Feuchtigkeit ausgesetzt war, nicht normal funktioniert oder fallen gelassen wurde.
15. Dieses Gerät vor Tropf- und Spritzwasser SCHÜTZEN. KEINE mit Wasser gefüllten Gegenstände wie zum Beispiel Vasen auf das Gerät STELLEN.
16. Der Netzstecker oder eine Gerätesteckerverbindung muss leicht zu betätigen sein.
17. Der Luftschall des Geräts überschreitet 70 dB (A) nicht.
18. Das Gerät mit Bauweise der KLASSE I muss mit einem Schukostecker mit Schutzleiter in eine Netzsteckdose mit Schutzleiter eingesteckt werden.
19. Dieses Gerät darf nicht Regen oder Feuchtigkeit ausgesetzt werden, um das Risiko von Bränden oder Stromschlägen zu verringern.
20. Nicht versuchen, dieses Produkt zu modifizieren. Ansonsten könnte es zu Verletzungen und/oder zum Produktausfall kommen.



Dieses Symbol zeigt an, dass gefährliche Spannungswerte, die ein Stromschlagrisiko darstellen, innerhalb dieses Geräts auftreten.



Dieses Symbol zeigt an, dass das diesem Gerät beiliegende Handbuch wichtige Betriebs- und Wartungsanweisungen enthält.

INSTRUCCIONES IMPORTANTES DE SEGURIDAD

1. LEA estas instrucciones.
2. CONSERVE estas instrucciones.
3. PRESTE ATENCIÓN a todas las advertencias.
4. SIGA todas las instrucciones.
5. NO utilice este aparato cerca del agua.
6. LIMPIE ÚNICAMENTE con un trapo seco.
7. NO obstruya ninguna de las aberturas de ventilación. Instale según lo indicado en las instrucciones del fabricante.
8. NO instale el aparato cerca de fuentes de calor tales como radiadores, registros de calefacción, estufas u otros aparatos (incluyendo amplificadores) que produzcan calor.
9. NO anule la función de seguridad del enchufe polarizado o con clavija de puesta a tierra. Un enchufe polarizado tiene dos patas, una más ancha que la otra. Un enchufe con puesta a tierra tiene dos patas y una tercera clavija con puesta a tierra. La pata más ancha o la tercera clavija se proporciona para su seguridad. Si el tomacorriente no es del tipo apropiado para el enchufe, consulte a un electricista para que sustituya el tomacorriente de estilo anticuado.
10. PROTEJA el cable eléctrico para evitar que personas lo pisen o estrujen, particularmente en sus enchufes, en los tomacorrientes y en el punto en el cual sale del aparato.
11. UTILICE únicamente los accesorios especificados por el fabricante.
12. UTILICE únicamente con un carro, pedestal, trípode, escuadra o mesa del tipo especificado por el fabricante o vendido con el aparato. Si se usa un carro, el mismo debe moverse con sumo cuidado para evitar que se vuelque con el aparato.



13. DESENCHUFE el aparato durante las tormentas eléctricas, o si no va a ser utilizado por un lapso prolongado.
14. TODA reparación debe ser llevada a cabo por técnicos calificados. El aparato requiere reparación si ha sufrido cualquier tipo de daño, incluyendo los daños al cordón o enchufe eléctrico, si se derrama líquido sobre el aparato o si caen objetos en su interior, si ha sido expuesto a la lluvia o la humedad, si no funciona de modo normal, o si se ha caído.
15. NO exponga este aparato a chorros o salpicaduras de líquidos. NO coloque objetos llenos con líquido, tales como floreros, sobre el aparato.
16. El enchufe de alimentación o un acoplador para otros aparatos deberá permanecer en buenas condiciones de funcionamiento.
17. El nivel de ruido transmitido por el aire del aparato no excede de 70 dB(A).
18. Los aparatos de fabricación CLASE I deberán conectarse a un tomacorriente de ALIMENTACION con clavija de puesta a tierra protectora.
19. Para reducir el riesgo de causar un incendio o sacudidas eléctricas, no exponga este aparato a la lluvia ni a humedad.
20. No intente modificar este producto. Hacerlo podría causar lesiones personales y/o la falla del producto.



Este símbolo indica que la unidad contiene niveles de voltaje peligrosos que representan un riesgo de choques eléctricos.



Este símbolo indica que la literatura que acompaña a esta unidad contiene instrucciones importantes de funcionamiento y mantenimiento.

ISTRUZIONI IMPORTANTI PER LA SICUREZZA

1. LEGGETE queste istruzioni.
2. CONSERVATELE.
3. OSSERVATE tutte le avvertenze.
4. SEGUITE tutte le istruzioni.
5. NON usate questo apparecchio vicino all'acqua.
6. PULITE l'apparecchio SOLO con un panno asciutto.
7. NON ostruite alcuna apertura per l'aria di raffreddamento. Installate l'apparecchio seguendo le istruzioni del costruttore.
8. NON installate l'apparecchio accanto a fonti di calore, quali radiatori, aperture per l'effluvio di aria calda, forni o altri apparecchi (amplificatori inclusi) che generano calore.
9. NON modificate la spina polarizzata o con spinotto di protezione per non alterarne la funzione di sicurezza. Una spina polarizzata è dotata di due lame, una più ampia dell'altra. Una spina con spinotto è dotata di due lame e di un terzo polo di messa a terra. La lama più ampia ed il terzo polo hanno lo scopo di tutelare la vostra incolumità. Se la spina in dotazione non si adatta alla presa di corrente, rivolgetevi ad un elettricista per far eseguire le modifiche necessarie.
10. EVITATE di calpestare il cavo di alimentazione o di comprimerlo, specie in corrispondenza di spine, prese di corrente e punto di uscita dall'apparecchio.
11. USATE ESCLUSIVAMENTE i dispositivi di collegamento e gli accessori specificati dal costruttore.
12. USATE l'apparecchio solo con carrelli, sostegni, treppiedi, staffe o tavoli specificati dal produttore o venduti unitamente all'apparecchio stesso. Se usate un carrello, fate attenzione quando lo spostate con l'apparecchio collocato su di esso, per evitare infortuni causati da un eventuale ribaltamento del carrello stesso.



13. Durante i temporali o in caso di inutilizzo prolungato dell'apparecchio, SCOLLEGATELO dalla presa di corrente.
14. Per qualsiasi intervento, RIVOLGETEVI a personale di assistenza qualificato. È necessario intervenire sull'apparecchio ogniqualvolta è stato danneggiato, in qualsiasi modo; ad esempio la spina o il cavo di alimentazione sono danneggiati, si è versato liquido sull'apparecchio o sono caduti oggetti su di esso, l'apparecchio è stato esposto alla pioggia o all'umidità, non funziona normalmente o è caduto.
15. NON esponete l'apparecchio a sgocciolamenti o spruzzi. NON appoggiate sull'apparecchio oggetti pieni di liquidi, ad esempio vasi da fiori.
16. La spina ELETRICA o l'accoppiatore per elettrodomestici deve restare prontamente utilizzabile.
17. Il rumore aereo dell'apparecchio non supera i 70 dB (A).
18. L'apparecchio appartenente alla CLASSE I deve essere collegato ad una presa elettrica dotata di messa a terra di protezione.
19. Per ridurre il rischio di incendio o folgorazione, non esponete questo apparecchio alla pioggia o all'umidità.
20. Non tentate di modificare il prodotto. Tale operazione può causare infortuni e/o il guasto del prodotto stesso.



Questo simbolo indica la presenza di alta tensione all'interno dell'apparecchio, che comporta il rischio di folgorazione.



Questo simbolo indica la presenza di istruzioni importanti per l'uso e la manutenzione nella documentazione in dotazione all'apparecchio.

IMPORTANTES INSTRUÇÕES DE SEGURANÇA

1. LEIA estas instruções.
2. GUARDE estas instruções.
3. PRESTE ATENÇÃO a todas as instruções.
4. SIGA todas as instruções.
5. NÃO use este aparelho perto de água.
6. LIMPE SOMENTE com um pano seco.
7. NÃO bloqueie nenhuma das aberturas de ventilação. Instale de acordo com as instruções do fabricante.
8. NÃO instale próximo de nenhuma fonte de calor, tais como radiadores, bocais de aquecimento, fornos ou outros aparelhos que produzam calor (inclusive amplificadores).
9. NÃO inutilize as características de segurança do conector polarizado ou com pino de aterramento. Um conector polarizado possui duas lâminas com uma mais larga do que a outra. Um conector com pino de aterramento possui duas lâminas e um terceiro pino de aterramento. É fornecida uma lâmina mais larga ou o terceiro pino para a sua segurança. Se por acaso o conector não se encaixar na tomada, chame um electricista para substituir a tomada obsoleta.
10. PROTEJA o cabo de alimentação, evitando que seja pisado ou que enrosque, especialmente nos conectores, nas tomadas elétricas de emprego geral e no ponto onde elas saem do aparelho.
11. USE SOMENTE acessórios/apetrechos especificados pelo fabricante.
12. USE somente com um carrinho, pedestal, tripé, suporte ou mesa especificados pelo fabricante ou vendidos com o aparelho. Quando utilizar um carrinho, tenha cuidado ao movimentar o conjunto aparelho/carrinho para evitar danos com a queda do mesmo.



13. DESLIGUE este aparelho da tomada elétrica durante tempestades com relâmpagos ou quando não seja utilizado por longo período.
14. DEIXE toda a manutenção sob a responsabilidade de uma equipe de manutenção qualificada. É necessário realizar a manutenção quando por algum motivo o aparelho tiver sido danificado de alguma forma, como por exemplo por dano do cabo de alimentação elétrica ou do seu conector, por derramamento de líquido ou queda de objetos no aparelho, se o aparelho tiver sido exposto à chuva ou à umidade, não esteja operando normalmente ou tenha sofrido queda.
15. NÃO exponha o aparelho a respingos ou goteiras. NÃO coloque objetos cheios de líquidos, tais como vasos, sobre o aparelho.
16. O plugue MAINS (rede elétrica) ou um acoplador de aparelho deve estar sempre pronto para operação.
17. O ruído aéreo do Aparelho não ultrapassa 70 dB (A).
18. O aparelho com construção CLASSE I deve estar conectado à tomada da rede elétrica com ligação à terra.
19. Para reduzir o risco de incêndio ou choque elétrico, não exponha este aparelho à chuva ou umidade.
20. Não tente alterar este produto. Isso poderá resultar em lesão pessoal e/ou falha do produto.



Este símbolo indica que existe nesta unidade tensão perigosa que apresenta risco de choque elétrico.



Este símbolo indica que existem instruções de operação e manutenção importantes na literatura que acompanha esta unidade.

ВАЖНЫЕ ИНСТРУКЦИИ ПО ТЕХНИКЕ БЕЗОПАСНОСТИ

1. ПРОЧИТАЙТЕ эти инструкции.
2. СОХРАНИТЕ эти инструкции.
3. ОБРАЩАЙТЕ ВНИМАНИЕ на все предупреждения.
4. СЛЕДУЙТЕ всем инструкциям.
5. НЕ пользуйтесь этим прибором вблизи воды.
6. ЧИСТИТЕ ТОЛЬКО сухой тканью.
7. НЕ закрывайте никакие вентиляционные отверстия. Произведите установку в соответствии с указаниями изготовителя.
8. НЕ устанавливайте вблизи каких бы то ни было источников тепла — радиаторов, обогревателей, печей или других приборов (включая усилители), выделяющих тепло.
9. НЕ пренебрегайте защитными свойствами поляризованной или заземляющей вилки. Поляризованная вилка имеет два ножевых контакта, из которых один шире другого. Заземляющая вилка имеет два ножевых контакта и третий, заземляющий, штырь. Более широкий контакт или третий штырь предназначены для повышения безопасности. Если вилка прибора не подходит к вашей розетке, обратитесь к электрику для замены розетки устаревшей конструкции.
10. ЗАЩИТИТЕ силовой шнур, чтобы на него не наступали и чтобы он не был пережат, особенно в местах подсоединения к вилкам, розеткам и в месте выхода из прибора.
11. ИСПОЛЬЗУЙТЕ ТОЛЬКО те принадлежности и приспособления, которые предусмотрены изготовителем.
12. ИСПОЛЬЗУЙТЕ только с тележкой, стендом, штативом, кронштейном или столом, которые предусмотрены изготовителем или наглухо прикреплены к прибору. При использовании тележки будьте осторожны, когда передвигаете тележку вместе с прибором — переворачивание может привести к травме.



13. ОТСОЕДИНЯЙТЕ прибор ОТ СЕТИ во время грозы или если он не используется длительное время.
14. ПОРУЧИТЕ все обслуживание квалифицированному техническому персоналу. Обслуживание требуется при каком-либо повреждении прибора, например, при повреждении шнура питания или вилки, если на прибор была пролита жидкость или на него упал какой-либо предмет, если прибор подвергся воздействию дождя или сырости, не функционирует нормально или если он падал.
15. НЕ допускайте попадания на прибор капель или брызг. НЕ ставьте на прибор сосуды с жидкостью, например, вазы.
16. Вилка электропитания или штепсель прибора должны быть легко доступны.
17. Уровень воздушного шума ЭТОГО аппарата не превышает 70 дБ (А).
18. Аппараты с конструкцией КЛАССА I следует подсоединять к розетке электропитания, имеющей гнездо для заземления.
19. Чтобы уменьшить риск возгорания или поражения электрическим током, не допускайте попадания на этот аппарат дождя или влаги.
20. Не пытайтесь вносить изменения в это изделие. Это может привести к травме и (или) выходу изделия из строя.



Этот знак показывает, что внутри прибора имеется опасное напряжение, создающее риск электрического удара.



Этот знак показывает, что в сопроводительной документации к прибору есть важные указания по его эксплуатации и обслуживанию.

중요 안전 지침

1. 이 지침을 정독해 주십시오.
2. 이 지침을 잘 보관해 주십시오.
3. 모든 경고를 유익하십시오.
4. 모든 지침을 준수하십시오.
5. 이 기기를 물 가까이 두고 사용하지 마십시오.
6. 마른 수건으로만 닦으십시오.
7. 통풍구를 막지 마십시오. 제조업체의 지침에 따라 설치하십시오.
8. 난방기, 방열 조절기, 스토브, 기타 열을 발산하는 기기 (앰프포함) 근처에 설치하지 마십시오.
9. 안전을 위해 유극 또는 접지 타입의 플러그를 반드시 사용하십시오. 유극 유형의 플러그에는 폭이 다른 핀이 있습니다. 접지형 플러그에는 두 개의 핀과 하나의 접지 단자가 있습니다. 넓은 핀이나 접지 단자는 사용자의 안전을 위한 것입니다. 제공된 플러그가 콘센트에 맞지 않으면 전기 기사에게 문의하여 구형 콘센트를 교체하십시오.
10. 전원 코드는 밟히지 않도록 주의하고 특히 전원 플러그 사이, 접속 소켓 및 기기에서 나오는 부분에 전원 코드가 끼이지 않도록 보호하십시오.
11. 제조업체가 지정한 부속품/부품만 사용하십시오.
12. 제조업체에서 지정하거나 기기와 함께 판매되는 카드, 스탠드, 받침대, 브래킷 또는 테이블에서만 사용하십시오. 카드를 사용하는 경우, 이동 시 카드와 기기가 넘어져 부상을 입지 않도록 주의하십시오.



13. 낙뢰시 또는 장기간 동안 사용하지 않을 때는 기기의 전원을 빼놓으십시오.
14. 모든 서비스는 자격을 갖춘 서비스 전문가에게 의뢰하십시오. 전원 코드나 플러그가 손상된 경우, 기기 안으로 액체를 들어가거나 물건을 떨어뜨린 경우, 기기가 비나 물에 젖은 경우, 기기가 정상적으로 작동하지 않는 경우 또는 기기를 떨어뜨린 경우와 같이 기기가 손상되었을 때는 서비스를 받아야 합니다.
15. 기기에 물을 떨어뜨리거나 뿌리지 마십시오. 물병과 같이 물이 담긴 물체를 기기 위에 올려놓지 마십시오.
16. MAINS 플러그나 기기용 커넥터는 작동가능한 상태로 남아 있어야 합니다.
17. AC 어댑터의 공기매개 잡음은 70dB을 초과하지 않아야 합니다.
18. CLASS I 구조의 기기는 MAINS 소켓 콘센트에 보호 접지 연결 방식으로 연결되어야 합니다.
19. 화재나 감전 위험을 줄이려면 이 기기를 빗물 또는 습기에 노출시키지 마십시오.
20. 이 제품을 고치려고 시도하지 마십시오. 그렇게 하면 사람이 다치거나 제품 고장을 일으킬 수 있습니다.



이 기호는 기기에 전기 쇼크 위험을 유발하는 위험한 전압이 흐른다는 것을 의미합니다.



이 기호는 이 기기와 함께 제공된 문서에 중요한 작동 및 유지 보수 지침의 내용이 들어 있다는 것을 의미합니다.

重要安全事項

1. 必須閱讀這些注意事項。
2. 必須保留這些注意事項。
3. 必須注意所有警告內容。
4. 必須遵循所有注意事項。
5. 不要在靠近水的地方使用本設備。
6. 只能用於布擦拭設備。
7. 不要堵塞任何通風口。遵循製造商的說明進行安裝。
8. 不要將本設備安裝在任何熱源附近，如散熱器、調溫器、火爐或其它可能產生熱量的裝置（包括功率放大器）。
9. 不要破壞帶極性或接地類型插頭的安全功能。極性插頭帶有兩個插片，其中一個較另一個寬。接地類型插頭帶有兩個插片和第三個接地插腳。較寬的插片或第三個插腳是為安全目的設置的。如果提供的插頭無法插入您的插座，請向電工諮詢如何更換合適的插座。
10. 保護電源線防止被腳踩或夾緊，尤其是在插頭、方便插座和機身電源線引出處。
11. 只能使用製造商指定的連接件/附件。
12. 只能使用製造商指定的或隨設備售出的手推車、支座、三角架、托架或支撐台。如果使用手推車，在移動裝有設備的手推車時應注意安全，避免設備翻落。



13. 在雷電天氣或長時間不使用時，應拔出設備的插頭。
14. 所有維修均應由合格的維修人員執行。在設備因以下情況損壞時，應進行維修：電源線或插頭損壞、液體濺到設備或異物進入設備，設備暴露在雨水或潮濕環境中而無法正常工作，或摔落到地上。
15. 不要將本設備暴露在可能滴水或濺水的地方。不要將裝有液體的容器（如花瓶等）放在本設備上。
16. 電源插頭或電器轉接頭應保持在隨時可用的狀態。
17. 本裝置的空氣噪聲不超過 70dB (A)。
18. 應將符合 I 類標準的設備連接到帶有接地保護裝置的主電源插座。
19. 為降低起火或電擊危險，不要將本設備暴露在雨中或潮濕環境下。
20. 不要嘗試改裝本產品。否則可能會導致人身傷害和/或產品故障。



這個符號表示本設備中存在可能導致觸電的危險電壓。



這個符號表示本設備附帶的說明書中具有重要的操作和維護說明。

安全にお使いいただくために

危険や損害の大きさと切迫の程度を明示するために、誤った扱いをすると生じることが想定される内容を次の定義のように「警告」「注意」の二つに区分しています。



この表示内容を無視して誤った取り扱いをすると、死亡または重傷を負う可能性が想定される内容です。



この表示内容を無視して誤った取り扱いをすると、傷害を負う可能性または物的損害が発生する可能性が想定される内容です。



- ・ 整備の際は、資格のある整備担当者に必ずご相談ください。電源コードやプラグの損傷、液体や異物が装置内に入り込んだ場合、装置が雨や湿気にさらされた場合、正常に作動しない場合、装置を落とした場合など、装置が何らかの状態で損傷した場合は、整備が必要です。
- ・ 装置に水滴やしぶきが付かないようにしてください。装置の上に花瓶などの液体の入った物を置かないでください。
- ・ 本製品の改造は試みないでください。改造した場合には怪我や製品故障の原因となります。



- ・ この製品は水の近くで使用しないでください。
- ・ 掃除は、必ず乾いた布で拭いてください。
- ・ 通風口を塞がないようにしてください。使用説明書に従って設置してください。
- ・ ラジエーターや暖房送風口、ストーブ、その他、熱を発生する機器（アンプなど）の近くには設置しないでください。
- ・ 有極プラグやアース付きプラグは安全のために用いられています。無効にしないようにしてください。有極プラグは、2本のブレードのうち一方が幅広になっています。アース付きプラグは、2本のブレードの他に、3本目のアースの棒がついています。幅広のブレードや3本目の棒は、安全のためにあるものです。これらのプラグがコンセントの差し込み口に合わない場合は、電気工事業者に相談し、コンセントを交換してもらってください。
- ・ 電源コードは、特にプラグ差し込み部分、延長コード、機器から出ている部分において、引っかかって抜けたり挟まれたりしないように保護してください。
- ・ アタッチメントや付属品は、必ずメーカー指定のものをご利用ください。
- ・ カートやスタンド、三脚、ブラケット、テーブル等は、メーカー指定のものか、この装置用に販売されているものを必ずご利用ください。カートを使用する場合は、装置を載せて移動する際、怪我をしないよう注意してください。
- ・ 雷を伴う嵐の際、または長期間使用しない場合は、プラグをコンセントから抜いてください。



●送信機技術基準適合証明ラベルについて

送信機は電波法で規定される技術基準適合証明品です。証明番号を記した証明ラベルが1台ずつ貼ってあります。表示の変更、除去は法律で禁じられていますので、みだりに剥がしたり、損傷することのないよう注意してください。

●違法改造について

機器を分解したり、内部の部品に触れたりしないでください。改造等は法律で禁じられています。

PETUNJUK PENTING KESELAMATAN

1. BACA petunjuk ini.
2. SIMPAN petunjuk ini.
3. PATUHI semua peringatan.
4. IKUTI semua petunjuk.
5. JANGAN gunakan perangkat ini dekat dengan air.
6. CUKUP DIBERSIHKAN dengan kain lap kering.
7. JANGAN halangi semua bukaan ventilasi. Pasang sesuai dengan petunjuk pabrik.
8. JANGAN pasang dekat dengan sumber panas seperti radiator, kisi-kisi tungku pemanas, kompor, atau perangkat lain (termasuk amplifier) yang menghasilkan panas.
9. JANGAN gagalkan tujuan keamanan steker terpolarisasi atau jenis pembumian. Steker terpolarisasi memiliki dua bilah dimana bilah yang satu lebih lebar dari yang lain. Steker jenis pembumian memiliki dua bilah dan tonjolan pembumian ketiga. Bilah yang lebih lebar atau tonjolan ketiga disediakan untuk keselamatan Anda. Jika steker yang disediakan tidak cocok dengan stopkontak Anda, hubungi petugas listrik untuk penggantian stopkontak yang sudah lama itu.
10. LINDUNGI kabel listrik agar aman dari injakan atau jepitan, terutama pada steker, stopkontak terbuka, dan titik yang menonjol dari perangkat itu.
11. HANYA GUNAKAN kelengkapan/aksesoris yang ditetapkan pabrik.
12. GUNAKAN hanya dengan kereta dorong, penyangga, tripod, braket atau meja yang ditetapkan oleh pabrikan, atau yang dijual bersama perangkat tersebut. Bila menggunakan kereta dorong, gunakan secara hati-hati ketika memindahkan secara bersama-sama kereta dorong/perangkat tersebut untuk menghindari cedera karena perangkat terguling.



13. CABUT perangkat ini selama petir atau bila tidak digunakan untuk waktu yang lama.
14. SERAHKAN semua servis ke petugas ahli. Servis diperlukan apabila perangkat tersebut sudah rusak dalam cara apapun, seperti kabel catu daya atau steker rusak, cairan tertumpah atau ada benda yang jatuh ke dalam perangkat, perangkat sudah terpapar hujan atau lembab, tidak bekerja normal, atau perangkat pernah jatuh.
15. JANGAN paparkan perangkat dengan tetesan dan percikan. JANGAN letakkan benda yang penuh dengan cairan, seperti pot bunga di atas perangkat tersebut.
16. Steker INDUK atau tusuk kontak harus tetap siap digunakan.
17. Kebisingan Perangkat ini yang bersumber dari udara tidak melebihi 70dB (A).
18. Perangkat dengan konstruksi KELAS I harus dihubungkan ke stopkontak soket INDUK dengan sambungan pembumian untuk pengamanan.
19. Untuk mengurangi resiko kebakaran atau sengatan listrik, jangan paparkan perangkat ini dengan hujan atau lembab.
20. Jangan coba-coba memodifikasi produk ini. Melakukannya dapat menyebabkan cedera diri dan/atau kerusakan produk.



Simbol ini menunjukkan bahwa voltase yang berbahaya menimbulkan resiko atau sengatan yang ada di dalam unit ini.



Lambang ini menunjukkan bahwa terdapat petunjuk kerja dan pemeliharaan penting pada bacaan yang melengkapi unit ini.

General Description

Shure ULX-D Digital Wireless offers uncompromising audio quality and RF performance, with intelligent, encryption-enabled hardware and advanced rechargeability options for professional sound reinforcement.

A breakthrough in wireless audio quality, Shure digital processing enables ULX-D to deliver the purest reproduction of source material ever available in a wireless system. Extended 20 Hz – 20 KHz frequency range and totally flat response captures every detail with clarity, presence, and incredibly accurate low-end and transient response. At greater than 120 dB, ULX-D delivers wide dynamic range for excellent signal-to-noise performance. For added convenience, proprietary Shure Gain Ranging optimizes the system's dynamic range for any input source, eliminating the need for transmitter gain adjustments.

In RF performance, ULX-D sets the bar for wireless channel efficiency and signal stability. Minimized intermodulation allows more transmitters to operate simultaneously over one TV channel than any other system. Rock-solid RF signal with no audio artifacts extends over the entire 100 meter line-of-sight range, even using standard dipole antennas. For applications where secure transmission is required, ULX-D offers Advanced Encryption Standard (AES) 256-bit encrypted signal for unbreachable privacy.

Advanced Lithium-ion rechargeability provides extended transmitter battery life over alkaline batteries, battery life metering in hours and minutes accurate to within 15 minutes, and detailed tracking of battery health status.

Generations ahead of any other available system in its class, ULX-D brings a new level of performance to professional sound reinforcement.

Features

Uncompromising Professional Digital Wireless

- 24-bit/48 KHz digital audio that exceeds all other systems in accurate reproduction of the source material
- 20 Hz – 20 KHz frequency range with flat response
- Greater than 120 dB dynamic range for excellent signal-to-noise performance
- Encryption-enabled for any application where secure transmission is needed:
 - Advanced Encryption Standard (AES-256) conforming to the US Government National Institute of Standards and Technology (NIST) publication FIPS-197
 - Enabled via front panel menu and IR sync
 - Added benefit of eliminating stray RF interference by allowing only encrypted signal through to the receiver
- Wide selection of trusted Shure Microphones

Extremely Efficient and Reliable RF Performance

- Up to 64 MHz overall tuning range (region dependent)
- Minimized intermodulation distortion results in significantly more channels on air, setting the bar for wireless performance in crowded RF environments
 - 14 active transmitters in one 6 MHz TV channel
 - 17 active transmitters in one 8 MHz TV channel
 - Over 60 compatible channels on one frequency band
- Rock-solid signal stability with no audio artifacts extends over the entire 100 meter line-of-sight range using standard supplied dipole antennas

Rugged, Intelligent Hardware

- Optimized scanning automatically finds and deploys the cleanest frequencies available
- Proprietary Shure Gain Ranging optimizes the system's dynamic range for any input source, eliminating the need for transmitter gain adjustments
- Up to 60 dB of adjustable system gain is easily accessible from the receiver front panel
- Networkable receiver simplifies setup across multiple channels
- AMX/Crestron control-compatible
- Rugged metal housing on both transmitters and receiver
- Interference detection and alerts provide instant confirmation when interference is present
- Upgraded LCD screens with adjustable contrast and brightness on both transmitters and receivers

Advanced Rechargeability - SB900 Shure Rechargeable Battery

- Lithium-ion chemistry and intelligent Shure battery circuitry results in rechargeable batteries with no memory effect. The battery can be recharged at any time; a complete discharge is never necessary
- Provides ULX-D transmitters with greater than 12 hours of continuous use
- Transmitters and receivers display remaining battery life in hours and minutes accurate to within 15 minutes
- The SBC200 Dual Docking Charger recharges batteries while in transmitters or out
- Up to four SBC200s can be linked together to provide docked charging of eight transmitters from one power supply
- The SBC800 Eight-Bay Charger brings up to eight SB900 batteries to full charge within three hours and 50% charge in one hour, with charge status LEDs for each battery
- AA alkaline backwards compatibility
- Both chargers fit in a standard-size rack drawer for easy transport and storage

Quickstart Instructions

1

a

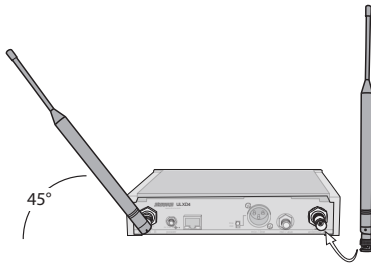

b

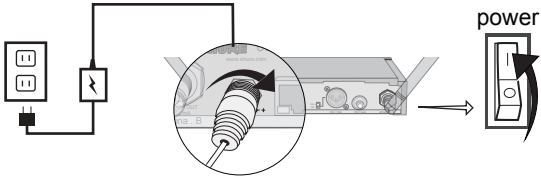

c

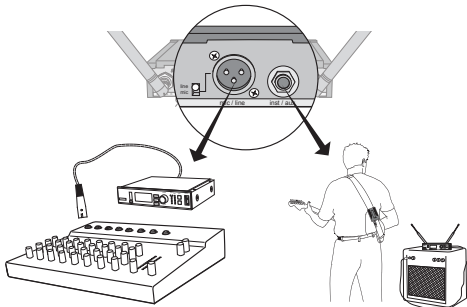

2

a

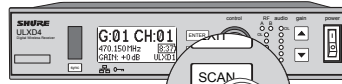

b

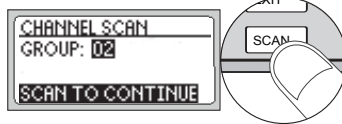
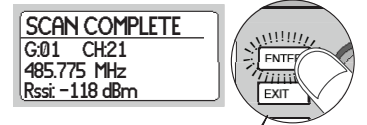
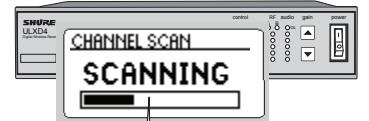

3

a

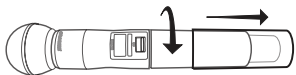

b

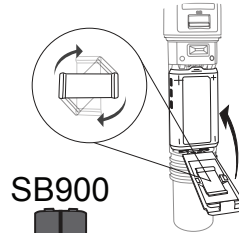
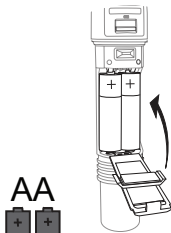

c

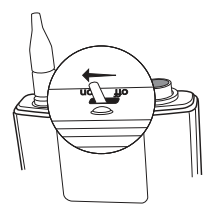
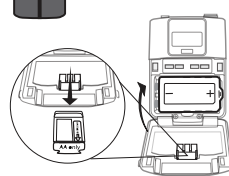
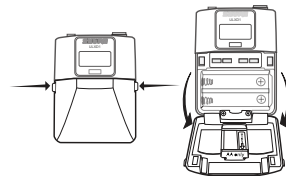
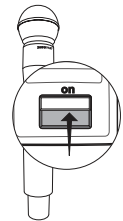

4

a

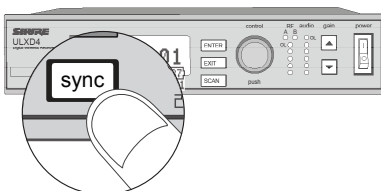

b

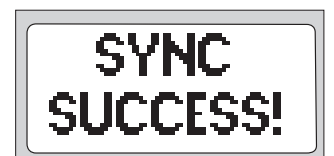
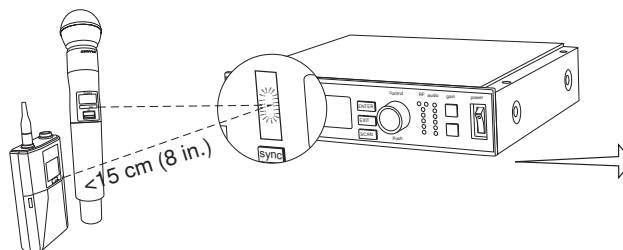

Receiver

Front Panel

① Sync Button

Press the **sync** button while the receiver and transmitter IR windows are aligned to transfer settings from the receiver to the transmitter

② Infrared (IR) Sync Window

Sends IR signal to the transmitter for sync

③ Network Icon

Illuminates when the receiver is connected with other Shure devices on the network. IP Address must be valid to enable networked control

④ Encryption Icon

Illuminates when AES-256 encryption is activated: **Utilities > Encryption**

⑤ LCD Panel

Displays settings and parameters

⑥ Scan Button

Press to find the best channel or group

⑦ Menu Navigation Buttons

Use to select and navigate through parameter menus

⑧ Control Wheel

Push to select menu items for editing, turn to edit a parameter value

⑨ RF Diversity LEDs

Indicate antenna status:

- Blue = normal RF signal between the receiver and transmitter
- Red = interference detected
- Off = No RF connection between the receiver and transmitter

Note: the receiver will not output audio unless one blue LED is illuminated

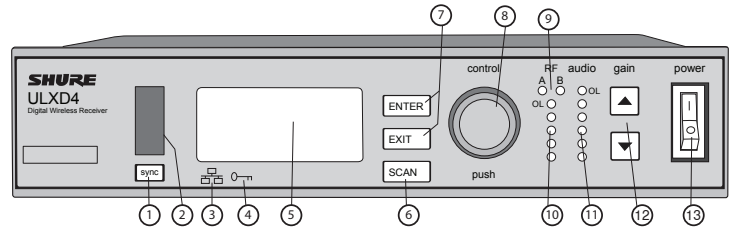

⑩ RF Signal Strength LEDs

Indicate the RF signal strength from the transmitter:

- Amber = Normal (-90 to -70 dBm)
- Red = Overload (greater than -25 dBm)

⑪ Audio LEDs

Indicate average and peak audio levels:

LED	Audio Signal Level	Description
Red (6)	-0.1 dBFS	Overload/ limiter
Yellow (5)	-6 dBFS	Normal peaks
Yellow/ Green (4)	-12 dBFS	
Green (3)	-20 dBFS	Signal Present
Green (2)	-30 dBFS	
Green (1)	-40 dBFS	

⑫ Gain Buttons

Adjust channel gain

⑬ Power Switch

Powers the unit on or off

Back Panel

① RF Antenna Diversity Input Jack (2)

For antenna A and antenna B.

② Power Supply Jack

Connect the supplied 15 V DC external power supply

③ Network Speed LED (Amber)

- Off = 10 Mbps
- On = 100 Mbps

④ Ethernet Port

Connect to an Ethernet network to enable remote control and monitoring

⑤ Network Status LED (Green)

- Off = no network link
- On = network link active
- Flashing = network link active, flash rate corresponds to traffic volume

⑥ Mic/Line Switch

Applies a 30 dB pad in mic position (XLR output only)

⑦ Balanced XLR Audio Output

Connect to a mic or line level input

⑧ Balanced 1/4" (6.35 mm) TRS Audio Output

Connect to a mic or line level input

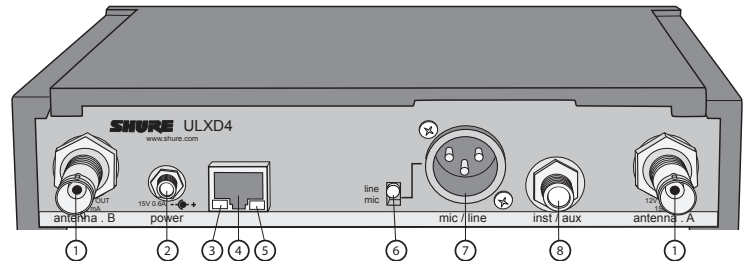

Receiver Output Level

The following table describes the typical total system gain from the audio input to the receiver outputs:

Output Jack	System Gain (gain control = 0dB)
1/4" TRS	+18 dB
XLR (line setting)	+24 dB
XLR (mic setting)	-6 dB*

*This setting matches a typical wired SM58 audio signal level.

Transmitters

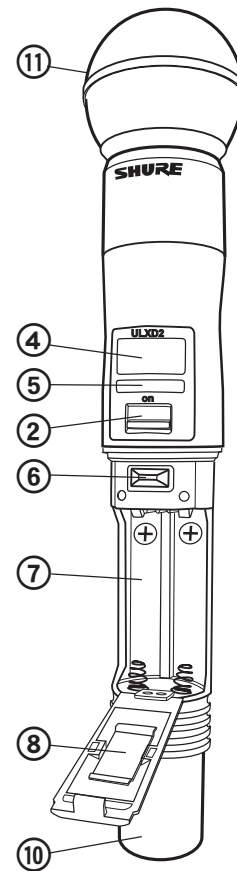
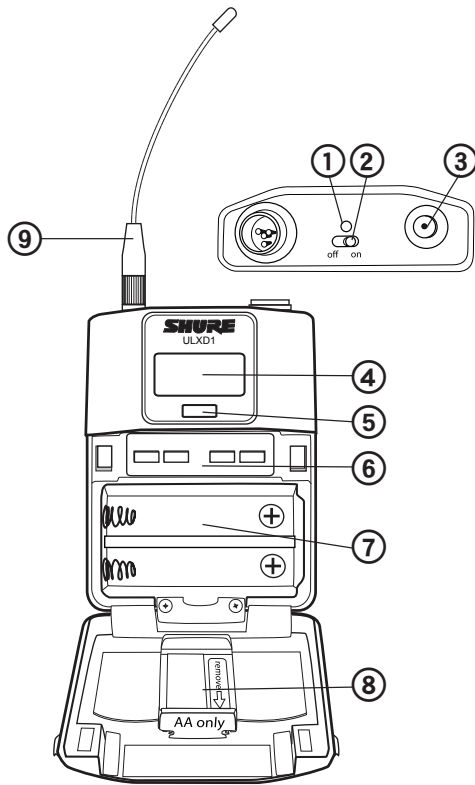

① Power LED

- Green = unit is powered on
- Red = low battery or battery error (see Troubleshooting)
- Amber = power switch is disabled

② On/Off Switch

Powers the unit on or off

③ TA4M Input Jack

Connects to a 4-Pin Mini Connector (TA4F) microphone or instrument cable

④ LCD Display:

View menu screens and settings. Press any control button to activate the backlight

⑤ Infrared (IR) Port

Align with the receiver IR port during an IR Sync for automated transmitter programming

⑥ Menu Navigation Buttons

Use to navigate through parameter menus and change values.

exit	Acts as a 'back' button to return to previous menus or parameters without confirming a value change
enter	Enters menu screens and confirms parameter changes
▼▲	Use to scroll through menu screens and to change parameter values

⑦ Battery Compartment

Requires Shure SB900 rechargeable battery or 2 AA batteries.

⑧ AA Battery Adapter

Handheld: rotate and store in the battery compartment to use a Shure rechargeable battery pack
Bodypack: remove to accommodate a Shure rechargeable battery pack

⑨ Detachable Bodypack Antenna

For RF signal transmission

⑩ Integrated Antenna

For RF signal transmission

⑪ Microphone Cartridge

See Optional Accessories for a list of compatible cartridges

Home Screen

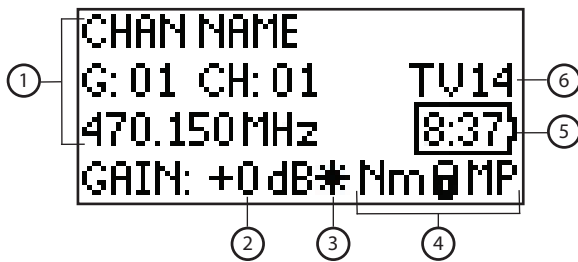

Receiver

- ① **Receiver Information**
Use UTILITIES > HOMEINFO to change the home screen display
- ② **Gain Setting**
-18 to +42 dB, or Mute
- ③ **Mic. Offset Indicator**
Indicates offset gain is added to the transmitter
- ④ **Transmitter Settings**
The following information cycles when a transmitter is tuned to the receiver's frequency:
 - Transmitter Type
 - Input Pad (Bodypack only)
 - RF Power Level
 - Transmitter Lock Status
- ⑤ **Battery Runtime Indicator**
Shure SB900 battery: runtime is displayed in minutes remaining
AA Batteries: runtime is displayed with a 5-bar indicator
- ⑥ **TV Channel**
Displays the TV channel that contains the tuned frequency

Transmitter Setting Icons

Display Icon	Transmitter Setting
-12dB	Bodypack input is attenuated 12 dB
*	Offset gain is added to the transmitter
Lo	1 mW RF power level
Nm	10 mW RF power level
Hi	20 mW RF power level
M	Menu is locked
P	Power is locked
-No TX-	No RF connection between a receiver and transmitter

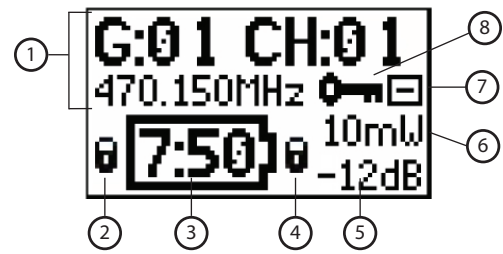

Transmitter

- ① **Transmitter Information**
Scroll ▲▼ at the home screen to change the display
- ② **Power Lock Indicator**
Indicates power switch is disabled
- ③ **Battery Runtime Indicator**
Shure SB900 battery: runtime is displayed in minutes remaining
AA Batteries: runtime is displayed with a 5-bar indicator
- ④ **Menu Lock Indicator**
Indicates menu navigation buttons are disabled
- ⑤ **Mic. Offset**
Displays microphone offset gain value
- ⑥ **RF Power**
Displays RF power setting
- ⑦ **Bodypack Input Pad**
The input signal is attenuated 12 dB
- ⑧ **Encryption Icon**
Indicates encryption is enabled on the receiver and has been transferred to the transmitter from a sync

Batteries

The transmitter runs on two AA batteries or the Shure SB900 rechargeable battery.

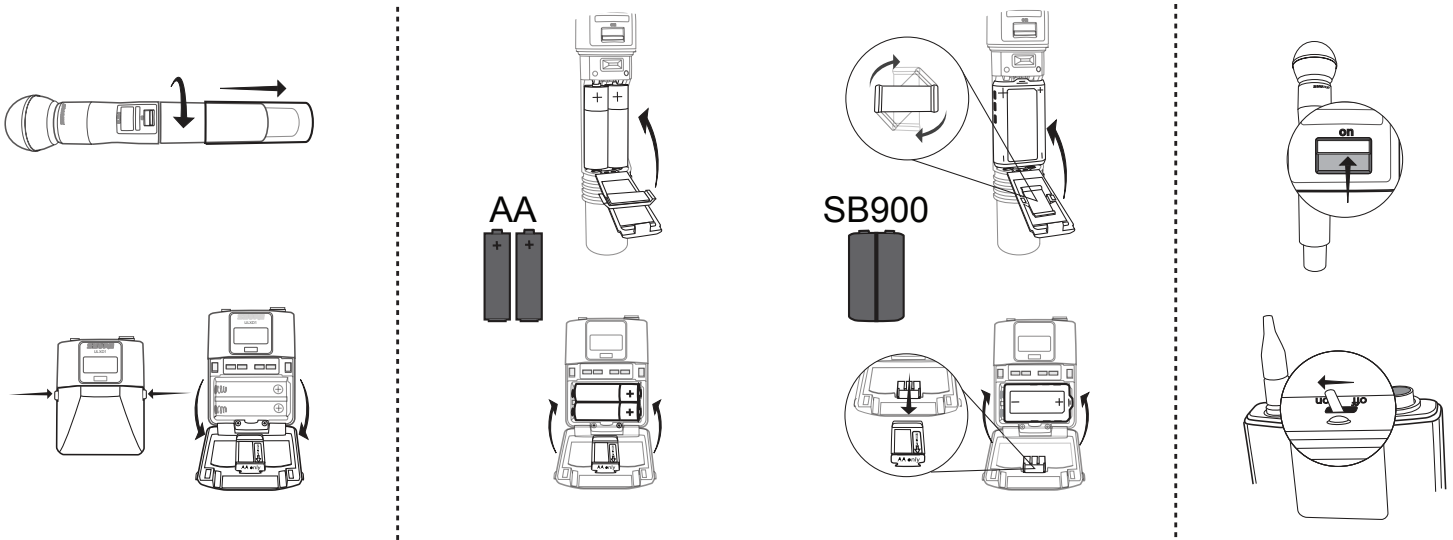







AA Batteries

 A 5-segment icon on the receiver and transmitter menu screens indicates battery charge.

For accurate battery runtime monitoring, set the transmitter to the appropriate battery type: **UTILITY > BATTERY > SETTYPE**.

AA Battery Runtime Chart (h:mm)

Battery Indicator	RF Power Setting	
	1/10 mW	20 mW
	11:00 to 9:35	5:30 to 4:55
	9:35 to 7:15	4:55 to 4:00
	7:15 to 4:45	4:00 to 2:30
	4:45 to 2:25	2:30 to 1:45
	2:25 to 00:45	1:45 to 0:25
	00:45 to 00:20	00:25 to 00:10

Shure SB900 Rechargeable Battery

 When using an SB900 rechargeable battery, the receiver and transmitter home screens display the number of hours and minutes remaining.

Detailed information for the SB900 is displayed in the receiver **BATTERYINFO** menu and the transmitter menu: **UTILITY > BATTERY > BATT.STATS**

HEALTH: Overall battery health

CHARGE: Percentage of a full charge

CYCLES: Number of times the battery has been charged

TEMP: Battery temperature in Celsius and Fahrenheit

Note: For additional rechargeable battery information, visit www.shure.com.

```

HEALTH: 90%
CHARGE: 80%
CYCLES: 100
TEMP: 10°C / 50°F
    
```

AA Battery Adapter

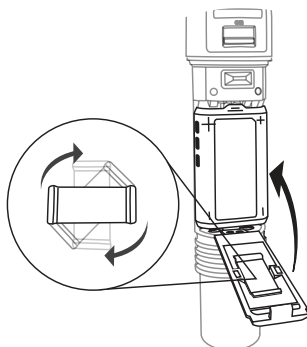

Handheld: Rotate and store in battery door when using Shure SBC900

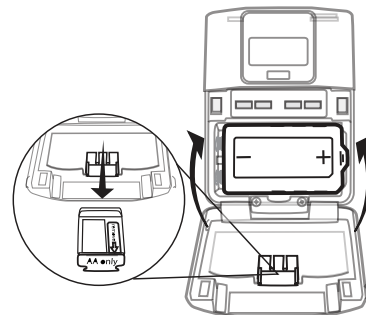

Bodypack: Remove when using the Shure SBC900

Setting Gain

Adjust gain at the receiver so that the average signal levels are solid green and yellow with peaks that flicker the red overload LED. Attenuate the gain if the signal overloads repeatedly.

Set the XLR output to line-level when possible to optimize sound system noise performance.

System Gain Control

The gain control on the receiver sets the audio signal level for the entire system. This allows adjustments to be made during a live performance. It is not necessary to change the gain on the transmitter (mic offset) to optimize the gain structure. Any required changes to gain should be made from the receiver.

Adjusting Gain

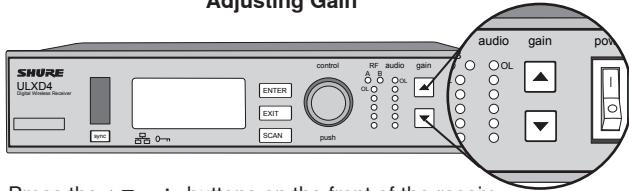

Press the ▲▼ gain buttons on the front of the receiver to incrementally adjust gain from -18 to +42 dB.

Large Gain Adjustments



Press and hold a gain button

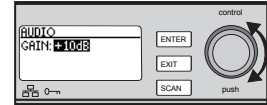

Use the control wheel in the AUDIO menu

Reading the Audio Meter

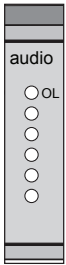

Audio peaks illuminate the LEDs for 2 seconds while RMS signal is displayed in realtime.

OL (Overload) LED: Illuminates red when the internal limiter is engaged, preventing digital clipping.

Mute

To mute the audio, use Shure Wireless Workbench® software or a third-party control device.

Transmitter Input Clip

The following warning displays on the receiver LCD panel when the transmitter input is clipped:



To correct, attenuate the signal source. If the source cannot be attenuated while using a bodypack transmitter, select **INPUT PAD** from the main menu to attenuate the input signal 12 dB.

Mic. Offset

Use this to compensate for signal level differences between transmitters that share the same receiver.

Set the offset gain on a low signal level transmitter to match a louder transmitter: **Utility > Mic.Offset**

Note: For normal gain adjustments, use the receiver gain buttons.

RF

RF Power

Reference the following table for setting RF Power:

RF Power Setting	System Range	Application
1 mW	33 m (100 ft.)	For increased channel reuse at close distances
10 mW	100 m (330 ft.)	Typical setups
20 mW	100 m (330 ft.)	For hostile RF environments or long-distance applications

Note: Using the 20 mW setting decreases the transmitter battery runtime and reduces the number of compatible systems.

Interference Detection

Interference Detection analyzes the quality of the RF signal and detects interference conditions that have caused an audio signal dropout. When interference is identified, the RF LEDs illuminate red and the following warning displays on the receiver LCD panel.



Perform a Scan and Sync during a performance break if the warning display persists or the audio drops out repeatedly.

Scan and Sync

Use this procedure to tune a receiver and transmitter to the best open channel.

Important! Before you begin:

Turn off all transmitters for the systems you are setting up. (This prevents them from interfering with the frequency scan.)

Turn on potential sources of interference such as other wireless systems or devices, computers, CD players, large LED panels, effects processors, and digital rack equipment so they are operating as they would be during the presentation or performance (so the scan will detect and avoid any interference they generate).

1. Perform a channel scan on the receiver: **SCAN > CHANNELSCAN**.
2. Select a group and press the **SCAN** button. **SCANNING** displays on the LCD while it searches for an open frequency.
3. After the scan completes, the receiver displays the group, channel and frequency of the best available channel. Press the flashing **ENTER** button to save the value to the receiver.
4. Power on the ULXD transmitter.
5. Press the **sync** button on the receiver.
6. Align the IR windows until the receiver IR port illuminates red.
7. When complete, **SYNC SUCCESS!** appears. The transmitter and receiver are now tuned to the same frequency.

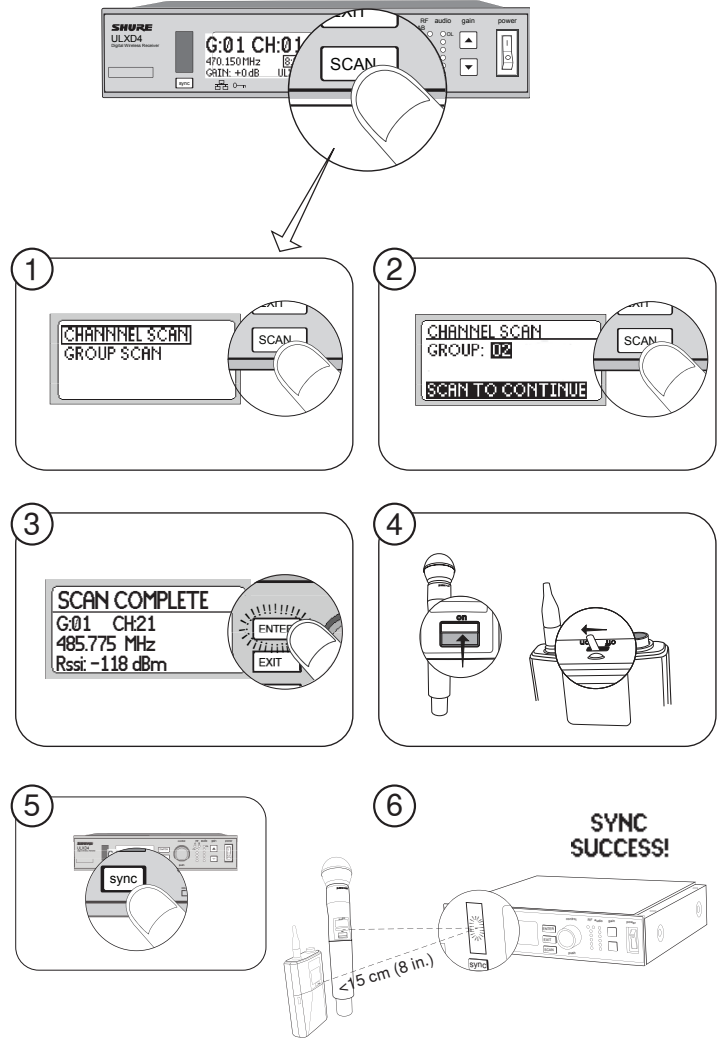

Multiple System Setup

A setup using networked receivers is the fastest and easiest way to distribute the best open channel to each system. See Networking Receivers for networking details.

Networked Receivers

1. Turn on all receivers.
2. Conduct a group scan on the first receiver to find the best group of frequencies in your RF environment: **SCAN > GROUPSCAN**.
3. Press **ENTER** to accept the group number and automatically assign the next best channel to each receiver on the network.
4. Turn on a transmitter and sync to the receiver. **Repeat this step for each additional system.**

Non-networked Receivers

1. Turn on all receivers.
2. Conduct a group scan on the first receiver to find the best group of frequencies in your RF environment: **SCAN > GROUPSCAN**
3. Select a group that contains enough open frequencies to accommodate the entire setup.
4. Turn on the transmitter and sync to the first receiver.
Repeat the following steps for each additional system:
5. Go to **SCAN > CHANNELSCAN** on the receiver to select the group assigned in step 2
6. Press the **SCAN** button to find the next best open frequency.
7. Press **ENTER** to assign the channel to the receiver.
8. Sync the transmitter to the receiver.

Manual Frequency Selection

To manually adjust group, channel or frequency, use the **RADIO > SETFREQ** menu.

Device ID

Name the receiver's Device ID to easily identify it through the network or in Wireless Workbench: **UTILITIES > NETWORKING > Dev.ID**

Networking Receivers

The receiver uses an Ethernet connection to network with other components. For automatic network configuration, use a DHCP enabled Ethernet switch such as the Shure AXT620. Use multiple Ethernet switches to extend the network for larger installations.

Note: Note use only one DHCP server per network.

Automatic IP Addressing

1. If using a Shure AXT620 Ethernet switch, set the DHCP switch to ON.
2. Set the IP Mode to Automatic for all receivers: **UTILITIES > NETWORKING > CTRLNETWORK**

Manual IP Addressing

1. Connect the receivers to an Ethernet switch.
2. Set the IP Mode to Manual for all devices (**UTILITIES > NETWORKING > MODE**)
3. Set compatible IP addresses for all devices.
4. Set the subnet mask to the same value for all devices.

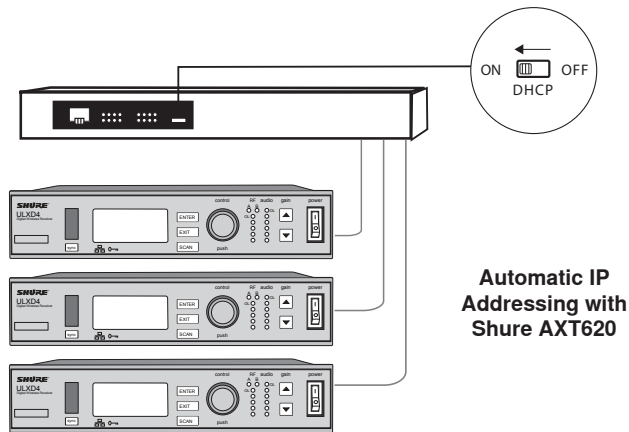

Troubleshooting

- Use only one DHCP server per network
- All devices must share the same subnet mask
- All receivers must have the same level of firmware revision installed
- Look for the illuminated network icon on the front panel of each device:
 - If the icon is not illuminated, check the cable connection and the LEDs on the network jack.
 - If the LEDs are not on and the cable is plugged in, replace the cable and recheck the LEDs and network icon.

To check connectivity of WWB6 to the network:

1. Start WWB6 software and use Inventory view to see devices connected to the network.
2. If not, find the IP address from one of the devices on the network (such as an ULXD receiver) and see if you can ping it from the computer running WWB6.
3. From a WINDOWS/MAC command prompt, type 'ping IPADDRESS' of the device (e.g. "ping 192.168.1.100").
4. If the ping returns success (no packet loss), then the computer can see the device on the network. If the ping returns failure (100% packet loss), then check the IP address of the computer to ensure it's on the same subnet as the Axient device.
5. If the pings are successful and the devices still do not show up in the WWB6 inventory, check to ensure all firewalls are either disabled or allow the WWB network traffic to pass to the application. Check that firewall settings are not blocking network access.

Home Screen Display Options

Receiver

Edit the following parameters in the **UTILITIES** menu:

EDITNAME: Edits the receiver's channel name (transfers to the transmitter during a sync).

HOMEINFO: Changes the information displayed on the LCD home screen:



DISPLAY: Use **BRIGHTNESS** parameter to adjust the brightness of the LCD panel, meter LEDs and front panel icons and **CONTRAST** parameter to adjust the contrast of the LCD panel.

Transmitter

Home Screen: Press the ▲▼ arrows at the home menu to display one of the following screens:

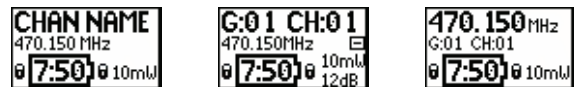

Locking Controls and Settings

Use the **LOCK** feature to prevent accidental or unauthorized changes to the hardware. Attempting to access a locked feature will display the following message:



Receiver

Menu path: **UTILITIES > LOCK**

MENU: All menu paths are inaccessible. To unlock, press the **EXIT** button, turn the control wheel to select **UNLOCKED** and press **ENTER** to save.

GAIN: Gain adjustment is locked

POWER: Power switch is disabled

SCN/SYC: Cannot perform a Scan and Sync

Transmitter

Menu path: **UTILITY > LOCK**

MENU: All menu paths are inaccessible. To unlock, press the **ENTER** button four (4) times to pass through the following screens: **UTILITY > LOCK > MENUUNLOCK**

POWER: Power switch is disabled

Quick-Lock Option: To turn on the transmitter with its power and menu navigation buttons locked, press and hold the **▲** button during power-on until the locked message is displayed.

To unlock, turn the power switch to the off position, then press and hold the **▲** button while turning the power switch to the on position.

Transmitter Presets

Use the **TXSYNCSETUP** menu to store settings on the receiver to transfer to the transmitter during a sync. Each parameter has the default value **KEEP**, which leaves that setting unaffected by a sync.

Feature	Setting
BPPAD	0 dB, -12 dB
LOCK	All, Power, Menu, None
RFPOWER	High, Mid, Low
BPOFFSET, HHOFFSET	0 dB to +21 dB (in 3 dB increments)
BATT	NiMH, Lithium, Alkaline
Cust. Group	On, Off

Note: When Cust. Groups is set to on, it may take up to 30 seconds to complete an IR sync.

Encryption

ULXD features Advanced Encryption Standard (AES-256) encryption, conforming to the US Government National Institute of Standards and Technology (NIST) publication FIPS-197.

1. Enable encryption on the receiver: **UTILITIES > ENCRYPTION**.
The encryption symbol illuminates green and the LCD displays **SYNCNOWFORENCRYPTION**.
2. Sync the transmitter to the receiver. The encryption symbol displays on the transmitter.

Note: Any change to the encryption status on the receiver requires a sync to transfer the setting to the transmitter. The Encryption Mismatch warning will display on the receiver LCD panel if they are not on the same setting.

System Reset

Use this feature to overwrite current settings with saved or factory default settings.

Save a System Preset

To save the current receiver setup as a new preset: **UTILITES > SYSTEMRESET > SAVE > CREATENEWPRESET**.

Restore Settings

To restore saved or factory default settings:

1. Go to **UTILITES > SYSTEMRESET > RESTORE**.
2. Scroll to the preset or default settings option and press **ENTER**. The following warning will display:
3. Press the flashing **ENTER** button to overwrite the current settings.

Advanced RF

RF Mute

Use this to turn on a transmitter without interfering with the RF spectrum.

Press and hold the **exit** button during power-on until **RFMUTED** is displayed. To un-mute, restart the transmitter.



Custom Groups

Use this feature to create up to six groups of manually selected frequencies that can be exported to networked receivers to simplify system setup.

To create a custom group: **UTILITES > ADVANCEDRF > CUSTOM GROUPS**

Note: Use Wireless Workbench or Wireless Frequency Finder to select the best compatible frequencies. See www.shure.com for more information.

To export a custom group:

1. Go to **UTILITES > ADVANCEDRF > CUSTOMGROUPS > EXPORT**. The following screen will display.
2. Press the flashing **ENTER** button to export all custom groups to all receivers on the network.

Antenna Bias

To turn off: **UTILITES > ADVANCEDRF > ANTENNABIAS**.

Firmware

Firmware is embedded software in each component that controls functionality. Periodically, new versions of firmware are developed to incorporate additional features and enhancements. To take advantage of design improvements, new versions of the firmware can be uploaded and installed using the Firmware Update Manager tool available in Shure's Wireless Workbench® (WWB) software. Software is available for download from <http://www.shure.com/wwb>.

Perform the following steps to update the firmware for the ULXD system:

1. From Shure Wireless Workbench software, open the Firmware Update Manager: **Tools > Firmware Update Manager**.
2. Click **Check Now** to view new versions available for download.
3. Select the updates and click **download**.
4. Connect the receiver and computer to the same network.
5. Download the latest firmware to the receiver.
6. To upload the firmware to the transmitter, go to **UTILITIES > TXFWUPDATE** on the receiver.
7. Place the transmitter on its side and align the IR ports.
8. Press **ENTER** on the receiver to begin the download to the transmitter. IR ports must be aligned for the entire download, which can take 50 seconds or longer.

Once the download is complete, the receiver automatically begins the firmware update, which overwrites the existing firmware.

CAUTION! Do not turn off the receiver until the update is complete.

Troubleshooting

Issue	See Solution...
No Sound	Power, Cables, or RF
Faint sound or distortion	Gain
Lack of range, unwanted noise bursts, or dropouts	RF
Cannot turn transmitter off or change frequency settings, or can't program receiver	Interface locks
Encryption error message	Encryption Mismatch

Power

Make sure that the receiver and transmitter are receiving sufficient voltage. Use the 15 V DC power supply furnished with the ULXD4 receiver. Check the battery indicators and replace the transmitter batteries if necessary.

Gain

Adjust the system gain on the front of the receiver. Ensure the output level (XLR output only) on the back of the receiver corresponds to the input of the mixing console, amplifier, or DSP.

Cables

Check that all cables and connectors are working correctly.

Interface Locks

The transmitter and the receiver can be locked to prevent accidental or unauthorized changes. A locked feature or button will produce the **Locked** screen on the LCD panel.

Encryption Mismatch

Re-sync the receiver and transmitter after enabling or disabling encryption.

Radio Frequency (RF)

RF LEDs

If neither blue **RF Diversity** LED is illuminated, then the receiver is not detecting the presence of a transmitter.

The amber **RF Signal Strength** LEDs indicate the amount of signal being received. This signal could be from the transmitter, **or it could be from an interfering source, such as a television broadcast**. If more than one or two of the amber **RF** LEDs are still illuminated while the transmitter is off, then that channel has too much interference, and you should try a different channel.

The red **RF** LED indicates RF overload. This will usually not cause a problem unless you are using more than one system at the same time, in which case, it can cause interference **in the other system**.

Compatibility

- Perform a Scan and Sync to ensure the transmitter and receiver are set to the same group and channel.
- Look at the label on the transmitter and receiver to make sure they are in the same band (G50, J50, L50, etc...).

Reducing Interference

- Perform a group or channel scan to find the best open frequency. Perform a sync to transfer the setting to the transmitter.
- For multiple systems, check that all systems are set to channels in the same group (systems in different bands do not need to be set to the same group).
- Maintain a line of sight between transmitter and receiver antennas.
- Move receiver antennas away from metal objects or other sources of RF interference (such as CD players, computers, digital effects, network switches, network cables and Personal Stereo Monitor (PSM) wireless systems).
- Eliminate RF overload (see below).

Increasing Range

If the transmitter is more than 6 to 60 m (20 to 200 ft) from the receiver antenna, you may be able to increase range by doing one of the following:

- Reduce interference (see above).
- Increase transmitter RF power level.
- Use an active directional antenna, antenna distribution system, or other antenna accessory to increase RF range.

Eliminating RF Overload

If you see the red RF LED on a receiver, try the following:

- Reduce the transmitter RF power level
- Move the transmitter further away from the receiver—at least 6 m (20 ft)
- If you are using active antennas, reduce antenna or amplifier gain.
- Use omnidirectional antennas

ULXD Specifications

RF Carrier Frequency Range	470–814 MHz, varies by region (See Frequency Range and Output Power table)
Working Range	100 m (330 ft) Note: Actual range depends on RF signal absorption, reflection and interference.
RF Tuning Step Size	25 kHz, varies by region
Image Rejection	>70 dB, typical
RF Sensitivity	-98 dBm at 10-5 BER
Latency	<2.9 ms
Audio Frequency Response	ULXD1: 20 – 20 kHz (±1 dB) ULXD2: Note: Dependent on microphone type
Audio Dynamic Range System Gain @ +10	>120 dB, A-weighted, typical
Total Harmonic Distortion -12 dBFS input, System Gain @ +10	<0.1%
System Audio Polarity	Positive pressure on microphone diaphragm produces positive voltage on pin 2 (with respect to pin 3 of XLR output) and the tip of the 6.35 mm (1/4-inch) output.
Operating Temperature Range	-18°C (0°F) to 50°C (122°F) Note: Battery characteristics may limit this range.
Storage Temperature Range	-29°C (-20°F) to 74°C (165°F) Note: Battery characteristics may limit this range.

ULXD4

Dimensions	197 mm x 171 mm x 42 mm (7.75 in. x 6.75 in. x 1.65 in.), H x W x D
Weight	913 g (2.0 lbs), without antennas
Housing	steel
Power Requirements	15 V DC @ 0.6 A, supplied by external power supply (tip positive)

RF Input

Spurious Rejection	>80 dB, typical
Connector Type	BNC
Impedance	50 Ω
Bias Voltage	12 - 13 V DC, 170 mA maximum, per antenna

Audio Output

Gain Adjustment Range	-18 to +42 dB in 1 dB steps (plus Mute setting)
Configuration	1/4" (6.35 mm): Impedance balanced (Tip=audio, Ring=no audio, Sleeve=ground) XLR: balanced (1=ground, 2=audio +, 3=audio -)
Impedance	1/4" (6.35 mm): 100 Ω (50 Ω Unbalanced) XLR: 100 Ω
Full Scale Output	1/4" (6.35 mm): +12 dBV XLR: LINE setting= +18 dBV, MIC setting= -12 dBV
Mic/Line Switch	30 dB pad
Phantom Power Protection	1/4" (6.35 mm): Yes XLR: Yes

Networking

Power Over Ethernet (PoE)	No, protected
Network Interface	Single Port Ethernet 10/100 Mbps
Network Addressing Capability	DHCP or Manual IP address
Maximum Cable Length	100 m (328 ft)

ULXD1

Gain Offset Range	0 to 21 dB (in 3 dB steps)
Battery Type	Shure SB900 Rechargeable Li-Ion or LR6 AA batteries 1.5 V
Battery Runtime @ 10 mW	Shure SB900: >12 hours alkaline: 11 hours See Battery Runtime Chart
Dimensions	86 mm x 66 mm x 23 mm (3.4 in. x 2.6 in. x 0.9 in.) H x W x D
Weight	142 g (5.0 oz.), without batteries
Housing	Cast aluminum

Audio Input

Connector	4-Pin male mini connector (TA4M), See drawing for details
Configuration	Unbalanced
Impedance	1 M Ω , See drawing for details
Maximum Input Level 1 kHz at 1% THD	Pad Off: 8.5 dBV (7.5 Vpp) Pad On: 20.5 dBV (30 Vpp)
Preamplifier Equivalent Input Noise (EIN) System Gain Setting \geq +20	-120 dBV, A-weighted, typical

RF Output

Connector	SMA
Antenna Type	1/4 wave
Impedance	50 Ω
Occupied Bandwidth	<200 kHz
Modulation Type	Shure proprietary digital
Power	1 mW, 10 mW, 20 mW See Frequency Range and Output Power table, varies by region

ULXD2

Gain Offset Range	0 to 21 dB (in 3 dB steps)
Battery Type	Shure SB900 Rechargeable Li-Ion or LR6 AA batteries 1.5 V
Battery Runtime @ 10 mW	Shure SB900: >12 hours alkaline: 11 hours See Battery Runtime Chart
Dimensions	256 mm x 51 mm (10.1 in. x 2.0 in.) L x Dia.
Weight	340 g (12.0 oz.), without batteries
Housing	Machined aluminum

Audio Input

Configuration	Unbalanced
Maximum Input Level 1 kHz at 1% THD	145 dB SPL (SM58), typical Note: Dependent on microphone type

RF Output

Antenna Type	Integrated Single Band Helical
Occupied Bandwidth	<200 kHz
Modulation Type	Shure proprietary digital
Power	1 mW, 10 mW, 20 mW See Frequency Range and Output Power table, varies by region

Tables and Diagrams

TA4M Connector

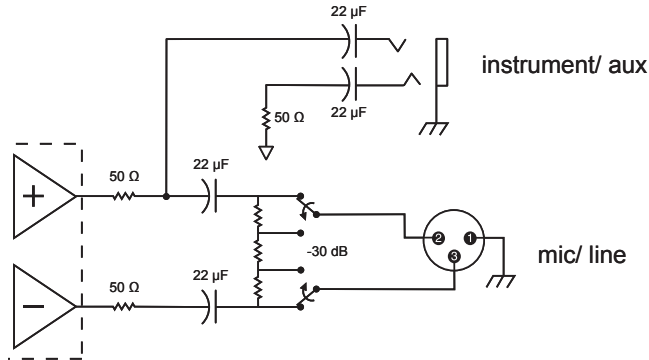
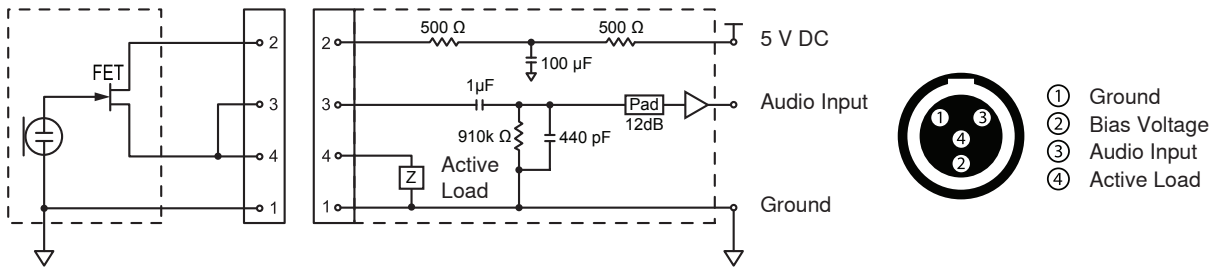

Battery Runtime

Battery Type	1 mW	10 mW	20 mW
SB900	>12 hours	>12 hours	>8 hours
Alkaline	<11 hours	<11 hours	<5.5 hours
NiMH	<11 hours	<11 hours	<8 hours
Li-primary	12.5-18 hours	12.5-18 hours	9.5-12 hours

The values in this table are typical of fresh, high quality batteries. Battery runtime varies depending on the manufacturer and age of the battery.

Frequency Range and Transmitter Output Power

Band	Frequency Range (MHz)	Power (mW)
G50	470 to 534	1/10/20
G51	470 to 534	1/10/20
G52	479 to 534	1/10
H51	534 to 598	1/10/20
H52	534 to 565	1/10
J50	572 to 636	1/10/20
K51	606 to 670	1/10
L50	632 to 696	1/10/20
L51	632 to 696	1/10/20
P51	710 to 782	1/10/20
R51	800 to 810	1/10/20
JB (Tx only)	806 to 810	1/10
AB (Rx and Tx)	770 to 810	"A" band (770.250-805.750): 1/10/20 "B" band (806.125-809.750): 1/10
Q51	794 to 806	1/10/20
X50	925 to 932	1/10

Furnished Accessories

All Systems

Receiver	ULXD4
Power Supply	xxxx
1/2 Wave Antenna (2)	95T9279
2' BNC Cable (2)	95K2035
BNC Bulkhead Adapters (2)	95A8994
Rackmount Kit (1)	90AZ8100
5' Ethernet Cable (1)	xxxx
AA Alkaline batteries (2)	80B8201

Handheld Systems

Handheld Transmitter	ULXD2
Cartridge	see options below
Microphone Clip	95T9279
Zipper Bag	95B2313

Choice of one (1) of the following:

SM58	RPW112
SM86	RPW114
SM87A	RPW116
Beta 58A	RPW118
Beta 87A	RPW120
Beta 87C	RPW122

Bodypack System

Bodypack Transmitter	ULXD1
Antenna	95G9043
Zipper Bag	95A2313

Choice of one (1) of the following:

Instrument cable	WA302
Instrument Clip-on microphone	Beta 98H/C
Lavalier microphone	MX150, MX153, WL183, WL184, WL185
Headset microphone	WH30TQG

Optional Accessories

Shure Rechargeable Battery	SB900
8-Bay Battery Charger	SBC800
Dual Docking Battery Charger	SBC200
AA Battery Adapter for Handheld Transmitter	95A15842
AA Battery Adapter for Bodypack Transmitter	65A15224
Passive Antenna Splitter/Combiner Kit	UA221
UHF Line Amplifier	UA830WB
UHF Antenna Power Distribution Amplifier (U.S.A.)	UA844SWB
UHF Antenna Power Distribution Amplifier (Europe)	UA844SE
UHF Antenna Power Distribution Amplifier (UK)	UA844UK
Antenna Rack Panel	UA440
Front Mount Antenna Kit (Includes 2 cables and 2 bulkhead adapters)	UA600
Remote Antenna Bracket with BNC Bulkhead Adapter	UA505
Rack Mount Kit for Two Receivers	UA507
UHF Powered Directional Antenna	UA870WB
8-to-1 antenna combiner for better RF performance	PA821SWB
4-to-1 antenna combiner with power distribution to 4 transmitters (better RF performance and eliminates need for external power supply)	PA421SWB
Passive Directional Antenna	PA805SWB
Coaxial Cable, BNC-BNC, RG58C/U type, 50 Ohm, 2 ft length (0.6 m)	UA802
Coaxial Cable, BNC-BNC, RG58C/U type, 50 Ohm, 6 ft length (2 m)	UA806
Coaxial Cable, BNC-BNC, RG8X/U type, 50 Ohm, 25 ft length (7.5 m)	UA825
Coaxial Cable, BNC-BNC, RG8X/U type, 50 Ohm, 50 ft length (15 m)	UA850
Coaxial Cable, BNC-BNC, RG213/U Type, 50 Ohm, 100 ft length (30 m)	UA8100

Certifications

ULXD1, ULXD2, ULXD4

Meets essential requirements of the following European Directives:

- Low Voltage Directive 2006/95/EC
- R&TTE Directive 99/5/EC
- WEEE Directive 2002/96/EC, as amended by 2008/34/EC
- RoHS Directive 2002/95/EC, as amended by 2008/35/EC

Note: Please follow your regional recycling scheme for electronic waste

Conforms to the relevant requirements of regulation (EC) No.278/2009, for low voltage external power supplies.

Meets requirements of the following standards: EN 300 422 Parts 1 and 2, EN 301 489 Parts 1 and 9.

ULXD1, ULXD2

Certified under FCC Part 74.

Certified by IC in Canada under RSS-123 and RSS-102.

IC: 616A-ULXD1 G50, 616A-ULXD1 J50, 616A-ULXD1 L50; 616A-ULXD2 G50, 616A-ULXD2 J50, 616A-ULXD2 L50.

FCC: DD4ULXD1G50, DD4ULXD1J50, DD4ULXD1L50; DD4ULXD2G50, DD4ULXD2J50, DD4ULXD2L50.

ULXD4

Approved under the Declaration of Conformity (DoC) provision of FCC Part 15.

Certified in Canada by IC to RSS-123.

IC: 616A-ULXD4 G50, 616A-ULXD4 J50, 616A-ULXD4 L50

This Class B digital apparatus complies with Canadian ICES-003. Cet appareil numérique de la classe B est conforme à la norme NMB-003 du Canada.

This device complies with Industry Canada licence-exempt RSS standard(s). Operation of this device is subject to the following two conditions: (1) this device may not cause interference, and (2) this device must accept any interference, including interference that may cause undesired operation of the device.

Le présent appareil est conforme aux CNR d'Industrie Canada applicables aux appareils radio exempts de licence. L'exploitation est autorisée aux deux conditions suivantes : (1) l'appareil ne doit pas produire de brouillage, et (2) l'utilisateur de l'appareil doit accepter tout brouillage radioélectrique subi, même si le brouillage est susceptible d'en compromettre le fonctionnement.

Note: EMC conformance testing is based on the use of supplied and recommended cable types. The use of other cable types may degrade EMC performance.

The CE Declaration of Conformity can be obtained from Shure Incorporated or any of its European representatives. For contact information please visit www.shure.com

The CE Declaration of Conformity can be obtained from: www.shure.com/europe/compliance

Authorized European representative:
Shure Europe GmbH
Headquarters Europe, Middle East & Africa
Department: EMEA Approval
Jakob-Dieffenbacher-Str. 12
75031 Eppingen, Germany
Phone: 49-7262-92 49 0
Fax: 49-7262-92 49 11 4
Email: info@shure.de

LICENSING INFORMATION

Licensing: A ministerial license to operate this equipment may be required in certain areas. Consult your national authority for possible requirements. Changes or modifications not expressly approved by Shure Incorporated could void your authority to operate the equipment. Licensing of Shure wireless microphone equipment is the user's responsibility, and licensability depends on the user's classification and application, and on the selected frequency. Shure strongly urges the user to contact the appropriate telecommunications authority concerning proper licensing, and before choosing and ordering frequencies.

Information to the user

This equipment has been tested and found to comply with the limits for a Class B digital device, pursuant to Part 15 of the FCC Rules. These limits are designed to provide reasonable protection against harmful interference in a residential installation. This equipment generates uses and can radiate radio frequency energy and, if not installed and used in accordance with the instructions, may cause harmful interference to radio communications. However, there is no guarantee that interference will not occur in a particular installation. If this equipment does cause harmful interference to radio or television reception, which can be determined by turning the equipment off and on, the user is encouraged to try to correct the interference by one or more of the following measures:

- Reorient or relocate the receiving antenna.
- Increase the separation between the equipment and the receiver.
- Connect the equipment to an outlet on a circuit different from that to which the receiver is connected.
- Consult the dealer or an experienced radio/TV technician for help.



WARNING: Danger of explosion if battery incorrectly replaced. Operate only with Shure compatible batteries.

Note: Use this receiver only with the included power supply or a Shure-approved equivalent.

WARNING

- Battery packs may explode or release toxic materials. Risk of fire or burns. Do not open, crush, modify, disassemble, heat above 140°F (60°C), or incinerate
- Follow instructions from manufacturer
- Never put batteries in mouth. If swallowed, contact your physician or local poison control center
- Do not short circuit; may cause burns or catch fire
- Do not charge or use battery packs with other than specified Shure products
- Dispose of battery packs properly. Check with local vendor for proper disposal of used battery packs
- Batteries (battery pack or batteries installed) shall not be exposed to excessive heat such as sunshine, fire or the like

FREQUENCIES FOR EUROPEAN COUNTRIES

ULXD-G51 470 - 534 MHz, max. 20 mW	
Country Code	Frequency Range
Code de Pays	Gamme de frequences
Codice di paese	Gamme di frequenza
Código de país	Gama de frecuencias
Länder-Kürzel	Frequenzbereich
A, B, BG, CH, CY, CZ, D, EST	470 - 534 MHz *
F, GB, GR, H, I, IS, L, LT	470 - 534 MHz *
NL, P, PL, S, SK, SLO	470 - 534 MHz *
DK, FIN, M, N	*
HR, E, IRL, LV, RO, TR	*
All other countries	*

ULXD-P51 710 - 782 MHz, max. 20 mW	
Country Code	Frequency Range
Code de Pays	Gamme de frequences
Codice di paese	Gamme di frequenza
Código de país	Gama de frecuencias
Länder-Kürzel	Frequenzbereich
A, B, BG, CH, CY, CZ, D, EST, F, GB,	710 - 782 MHz *
GR, H, I, IS, L, LT, NL, P, PL, S, SK, SLO	710 - 782 MHz *
RO	"718-719; 726-727; 734-743; 750-751; 758-759 MHz"
DK, E, FIN, HR, IRL, LV, M, N, TR	*
all other countries	*

ULXD-H51 534 - 598 MHz, max. 20 mW	
Country Code	Frequency Range
Code de Pays	Gamme de frequences
Codice di paese	Gamme di frequenza
Código de país	Gama de frecuencias
Länder-Kürzel	Frequenzbereich
A, B, BG, CH, CY, CZ, D, EST	534 - 598 MHz *
F, GB, GR, H, I, IS, L, LT	534 - 598 MHz *
NL, P, PL, S, SK, SLO	534 - 598 MHz *
DK, FIN, M, N	*
HR, E, IRL, LV, RO, TR	*
All other countries	*

ULXD-R51 800 - 810 MHz, max. 20 mW	
Country Code	Frequency Range
Code de Pays	Gamme de frequences
Codice di paese	Gamme di frequenza
Código de país	Gama de frecuencias
Länder-Kürzel	Frequenzbereich
N	800 - 810 MHz*
A, B, BG, CH, CY, CZ, D, DK, E, EST	*
F, FIN, GB, GR, H, HR, I, IRL, IS, L, LT	*
LV, M, N, NL, P, PL, S, SK, SLO, TR	*
All other countries	*

ULXD-K51 606 - 670 MHz, max. 20 mW	
Country Code	Frequency Range
Code de Pays	Gamme de frequences
Codice di paese	Gamme di frequenza
Código de país	Gama de frecuencias
Länder-Kürzel	Frequenzbereich
A, B, BG, CH, CY, CZ, D, EST	606 - 670 MHz *
F, GB, GR, H, I, IS, L, LT	606 - 670 MHz *
NL, P, PL, S, SK, SLO	606 - 670 MHz *
RO	646-647;654-655;662-663 MHz*
DK, E, FIN, HR, IRL, LV, M, N, TR	*
All other countries	*

* IMPORTANT

NOTE: THIS EQUIPMENT MAY BE CAPABLE OF OPERATING ON SOME FREQUENCIES NOT AUTHORIZED IN YOUR REGION. PLEASE CONTACT YOUR NATIONAL AUTHORITY TO OBTAIN INFORMATION ON AUTHORIZED FREQUENCIES AND RF POWER LEVELS FOR WIRELESS MICROPHONE PRODUCTS IN YOUR REGION.

A ministerial license may be required to operate this equipment in certain areas. Consult your national authority for possible requirements.

* WICHTIG

HINWEIS: DIESES GERÄT KANN MÖGLICHERWEISE AUF EINIGEN FREQUENZEN ARBEITEN, DIE IN IHREM GEBIET NICHT ZUGELASSEN SIND. WENDEN SIE SICH BITTE AN DIE ZUSTÄNDIGE BEHÖRDE, UM INFORMATIONEN ÜBER ZUGELASSENE FREQUENZEN UND ERLAUBTE SENDELEISTUNGEN FÜR DRAHTLOSE MIKROFONPRODUKTE IN IHREM GEBIET ZU ERHALTEN.

Zulassung: In einigen Gebieten ist für den Betrieb dieses Geräts u.U. eine behördliche Zulassung erforderlich. Wenden Sie sich bitte an die zuständige Behörde, um Informationen über etwaige Anforderungen zu erhalten.

*IMPORTANT

REMARQUE: IL EST POSSIBLE QUE CE MATÉRIEL SOIT CAPABLE DE FONCTIONNER SUR CERTAINES FRÉQUENCES NON AUTORISÉES LOCALEMENT. SE METTRE EN RAPPORT AVEC LES AUTORITÉS COMPÉTENTES POUR OBTENIR LES INFORMATIONS SUR LES FRÉQUENCES ET NIVEAUX DE PUISSANCE HF AUTORISÉES POUR LES SYSTÈMES DE MICROPHONES SANS FIL LOCALEMENT.

Autorisation d'utilisation : Une licence officielle d'utilisation de ce matériel peut être requise dans certains pays. Consulter les autorités compétentes pour les exigences possibles.

*IMPORTANTE

NOTA: QUESTO APPARECCHIO PUÒ ESSERE IN GRADO DI FUNZIONARE A FREQUENZE NON AUTORIZZATE NELLA REGIONE IN CUI SI TROVA L'UTENTE. RIVOLGERSI ALLE AUTORITÀ COMPETENTI PER OTTENERE LE INFORMAZIONI RELATIVE ALLE FREQUENZE ED AI LIVELLI DI POTENZA RF AUTORIZZATE NELLA PROPRIA REGIONE PER I PRODOTTI MICROFONICI SENZA FILI.

Concessione della licenza all'uso: per usare questo apparecchio, in certe aree può essere necessaria una licenza ministeriale. Per i possibili requisiti, rivolgersi alle autorità competenti.

*IMPORTANTE

NOTA: ES POSIBLE QUE ESTE EQUIPO FUNCIONE EN ALGUNAS FRECUENCIAS NO AUTORIZADAS EN SU REGION. POR FAVOR CONTACTE A LA AUTORIDAD NACIONAL PARA OBTENER INFORMACION ACERCA DE LAS FRECUENCIAS AUTORIZADAS Y LOS NIVELES DE POTENCIA DE RADIOFRECUENCIA PARA PRODUCTOS CON MICROFONOS INALAMBRICOS EN SU ZONA.

Licencia de uso: Se puede requerir una licencia ministerial para utilizar este equipo en algunas áreas. Consulte a la autoridad nacional sobre los posibles requisitos.



**United States, Canada, Latin
America, Caribbean:**

Shure Incorporated
5800 West Touhy Avenue
Niles, IL 60714-4608 USA

Phone: 847-600-2000
Fax: 847-600-1212 (USA)
Fax: 847-600-6446
Email: info@shure.com

Europe, Middle East, Africa:

Shure Europe GmbH
Jakob-Dieffenbacher-Str. 12,
75031 Eppingen, Germany

Phone: 49-7262-92490
Fax: 49-7262-9249114
Email: info@shure.de

Asia, Pacific:

Shure Asia Limited
22/F, 625 King's Road
North Point, Island East
Hong Kong

Phone: 852-2893-4290
Fax: 852-2893-4055
Email: info@shure.com.hk